

Varenummer: 20141V40B402BL
 Beskrivelse: E+G Kryds m/flange
 GN141-V40-B40-2-BL

Mål

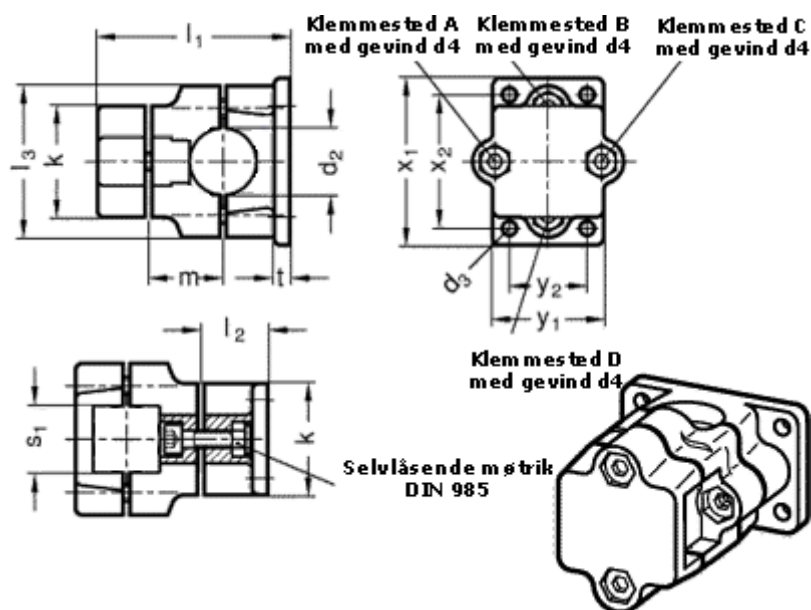

$d_2 = 40$	$s_1 = 40$
$d_3 = 11$	$t = 14$
$d_4 = M10$	Vippehåndtag = GN 911-M10-63 skal bestilles separat
$k = 76$	$x_1 = 115$
$l_1 = 136$	$x_2 = 90$
$l_2 = 46$	$y_1 = 76$
$l_3 = 98$	$y_2 = 50$
$m = 55$	